

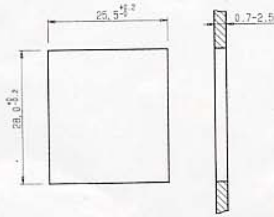

MOS

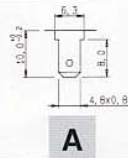

D K ? [] [] [] [] [] [] 0 0 0 0

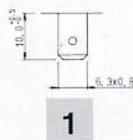
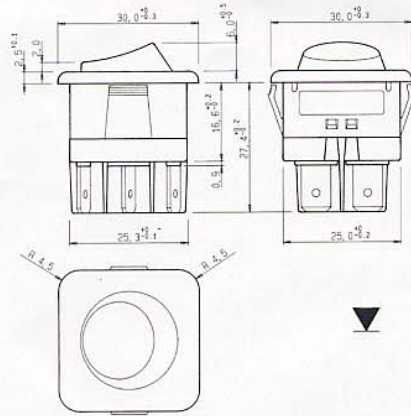

D K [] ? [] [] [] [] [] 0 0 0 0



1

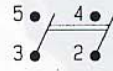

2



3



4

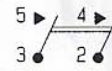

7

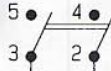

8



B

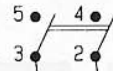

L

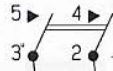

M

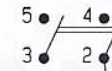

N



W

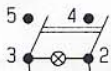

V

D K [] [] ? [] [] [] [] 0 0 0 0



16A-6(6)A/250V~
10A-4(4)A/250V -5E4
T125 °C

C

16A/125VAC
8A/250VAC
T65 °C

D K [] [] [] [?] [] [] [] 0 0 0 0

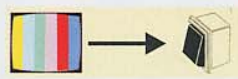
	51	52	57	61	75	71	65	90	54	77				
	1	2	3	4	5	6	8	9	A	Z				

D K [] [] [] [] [?] [] [] 0 0 0 0

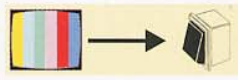





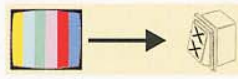

	51	52	57	61	75	71	65	90	54	652	77		
	1	2	3	4	5	6	8	9	A	B	Z		

	151	152	153	155	154	150							
	G	H	E	L	K	F							

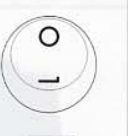
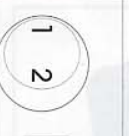
D K [] [] [] [] [] [?] [?] [] 0 0 0 0

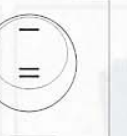
	01	02	03	04	05	06	07	08	09	10	14			?
	1	2	3	4	5	6	7	8	9	A	B	0	X	

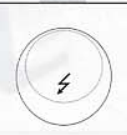
D K [] [] [] [] [] [] [?] 0 0 0 0

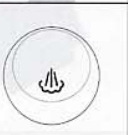
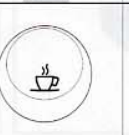
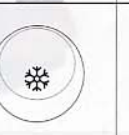
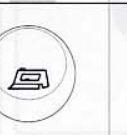
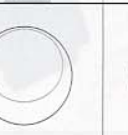
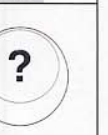
								
	A	B	C	D	F	H	L	M
								
	N	R	S	T	U	V	0	X

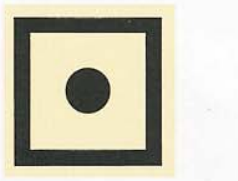
	0	1	D	K	0	2	D	K
	