

L-series Sensitive Light Force Switch

Specifications

L41:	0.1A 125/250VAC	> 100,000 cycles
	25T85	
L42:	5A 125/250VAC	> 100,000 cycles
	25T85	
L51:	0.1A 125/250VAC	> 100,000 cycles
	25T125	
L52:	5A 125/250VAC	> 100,000 cycles
	25T125	
L61:	0.1A 125/250	> 100,000 cycles
	25T150	
L62:	5A 125/250VAC	> 100,000 cycles
	25T150	
Mechanical Life:	1,000,000 cycles min.	
Insulation Resistance:	100 MΩ min.	
Dielectric Strength:	1000VAC for 60 +/- 5 sec	
Housing:	UL 94V0 Thermoplastic	



Ordering qty: 200pcs
Switch with lever: 1000pcs

Ordering Instructions

L52 A D - A A 00 Ag - 01

Series	Circuitry	Operating Force	Terminal Type	Lever Position	Lever Type	Contact Type	Versions
L41~L42	A=SPDT	D	Ref. to table	A: standard position	01, 02, 03..99	Ag = silver	Standard: 01
L51~L52	B=SPST-NC	F		B: high gear position	A1, A2..ZZ	Au = gold plated	Custom-made:
L61~L62	C=SPST-NO	G		N: no lever	00: no lever		02, 03, 04, ..99
		H					

Basic Switch Dimensions

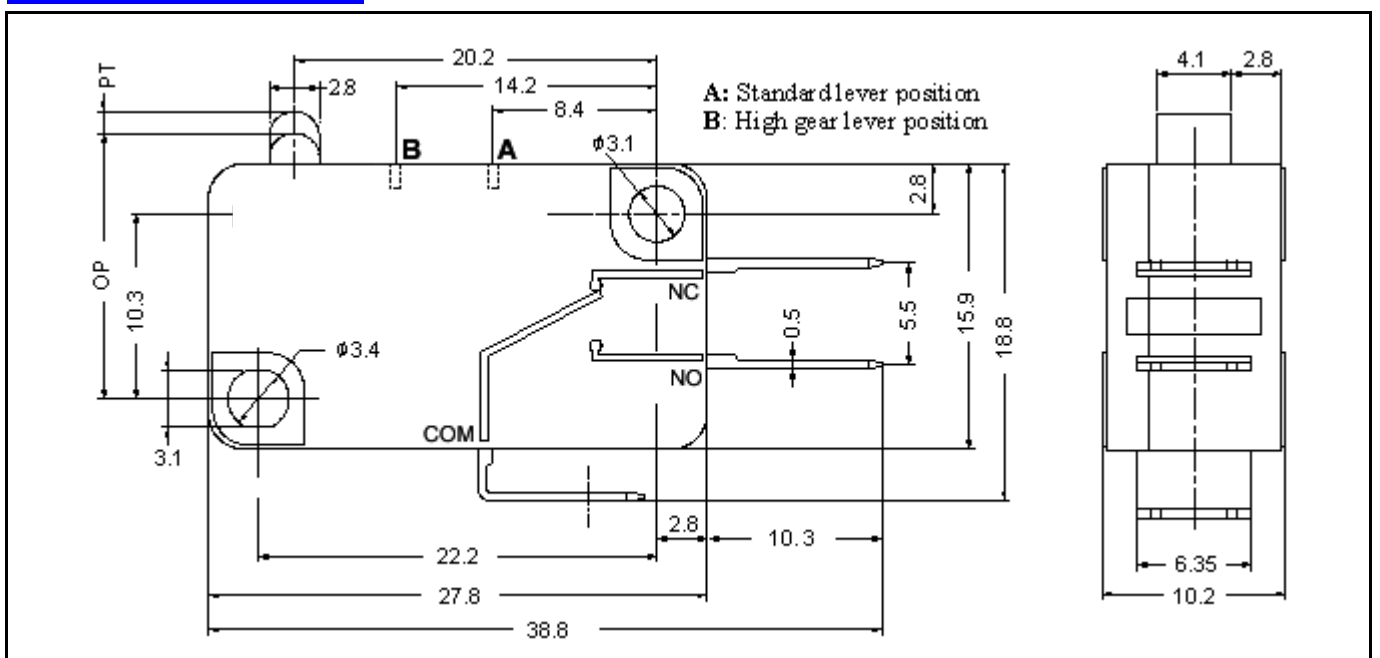

Standard Terminals

A: 6.3X0.8 Terminals

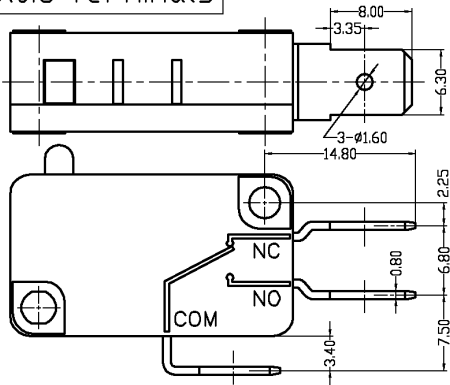

B: 4.8X0.5 Terminals

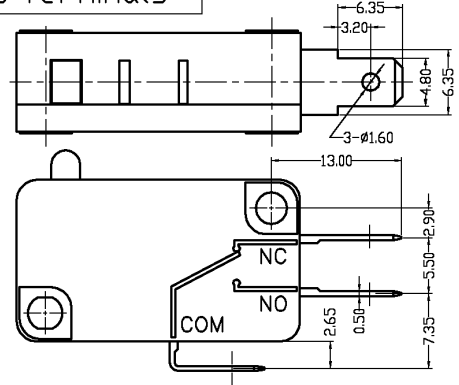

C: Solder Terminals

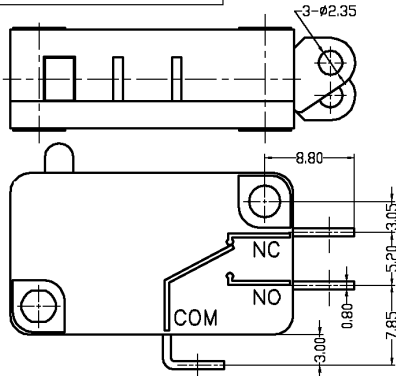

D: Screw Terminals

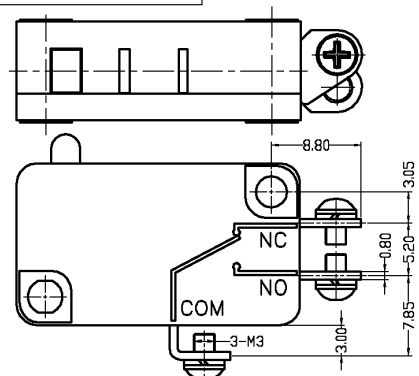

P: PCB Terminals-Right

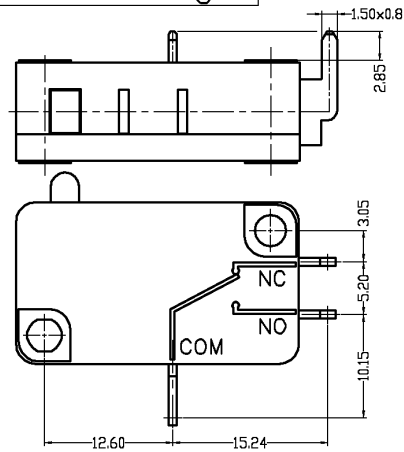

Q: PCB Terminals-Left

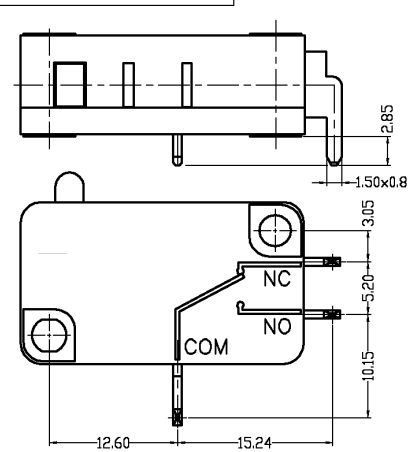

R: 6.3X0.8, RAST-5 Terminals

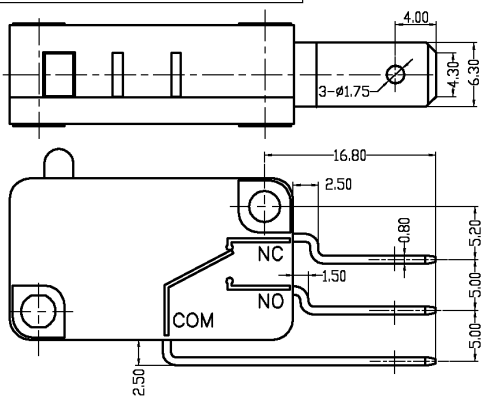

S: 4.8X0.8 Terminals

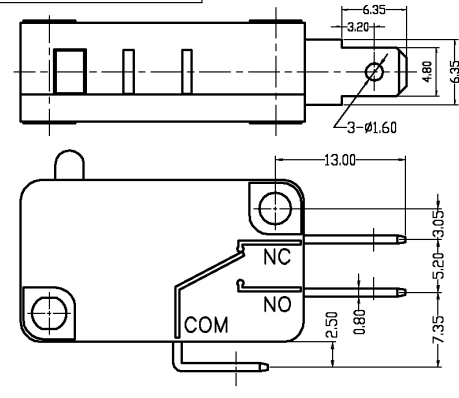

Standard Products

Series	Operating Temperature	Ratings	Operating force	Differential Movement	Differential Force
L41	25T85	0.1A 125/250VAC	D= 15gf max. F= 25gf max. G= 50gf max. H= 15gf max.	0.3mm max 0.3mm max 0.3mm max 0.15mm max	6gf max. 9gf max. 16gf max. 4gf max.
L42	25T85	5A 125/250VAC	D= 15gf max. F= 25gf max. G= 50gf max. H= 15gf max.	0.3mm max 0.3mm max 0.3mm max 0.15mm max	6gf max. 9gf max. 16gf max. 4gf max.
L51	25T125	0.1A 125/250VAC	D= 15gf max. F= 25gf max. G= 50gf max.	0.3mm max 0.3mm max 0.3mm max	6gf max. 9gf max. 16gf max.
L52	25T125	5A 125/250VAC	D= 15gf max. F= 25gf max. G= 50gf max.	0.3mm max 0.3mm max 0.3mm max	6gf max. 9gf max. 16gf max.
L61	25T150	0.1A 125/250VAC	D= 15gf max. F= 25gf max. G= 50gf max.	0.3mm max 0.3mm max 0.3mm max	6gf max. 9gf max. 16gf max.
L62	25T150	5A 125/250VAC	D= 15gf max. F= 25gf max. G= 50gf max.	0.3mm max 0.3mm max 0.3mm max	6gf max. 9gf max. 16gf max.

Special Characteristics:

Switches with operating force **H** is different from the others by their small Differential Movement and Differential Force:

$$Differential\ Force = Operating\ Force - Release\ Force$$

This switch is useful in control systems in which force measurement is extremely critical in the ON/OFF operations, a consistent and fixed operating point is required, sensitive and quick response to changes in force/pressure on the actuator.

Standard Products

Molveno OEM Service L-series micro is a highly sensitive device. If you need an external lever for your application, please let us know the details of your application and your drawing. Our factory will evaluate each case for you in terms of reliability and stability of the complete control system. Please contact Molveno OEM Service Sales Representatives for more details.